

BTS-500BT BlueSwitch

Operation Instructions

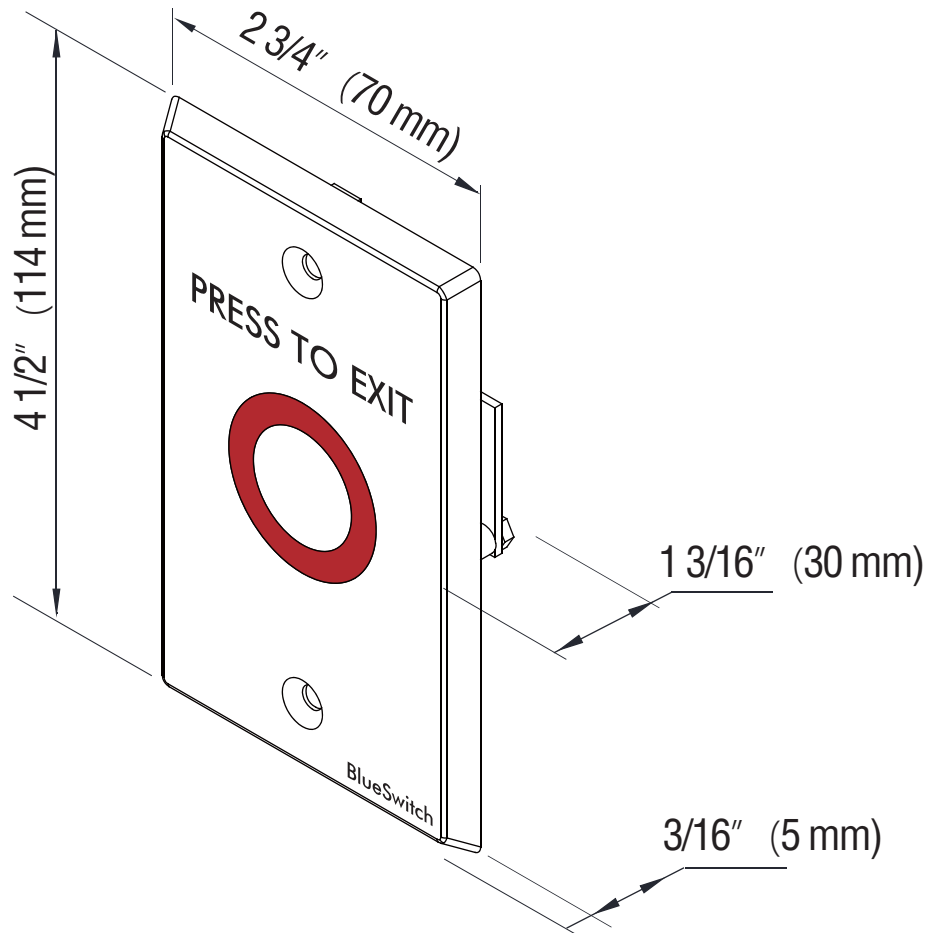

◆ Features

- 1 Administrator & 1000 Users
- Provides Bluetooth smartphone or push button unlocking
- Anti-tailgate
- LED & Audible indicator
- User Management
 1. Add/Delete/View user data
 2. Grant user access for specific dates or time periods
 3. Change user passcode
 4. Up to 1,000 audit trails
- 3 Locking options: Door Relock Time, Door Always Unlocked, Door Always Locked

◆ Specifications

Operating Voltage	12~24VDC
Current Draw	40mA/12VDC; 20mA/24VDC
Relay Contacts	NC/COM/NO
Contact Rating	5A/30VDC ; 5A/250VAC
Relock Time	1~1800 seconds (adjustable on APP)
Indicator Light	Standby : Solid Red Active : Solid Green
Temperature	-20~+70°C
Bluetooth Module	BLE 4.2
Auto Proximity Range	0~20 meters (adjustable)

◆ Installation Diagram

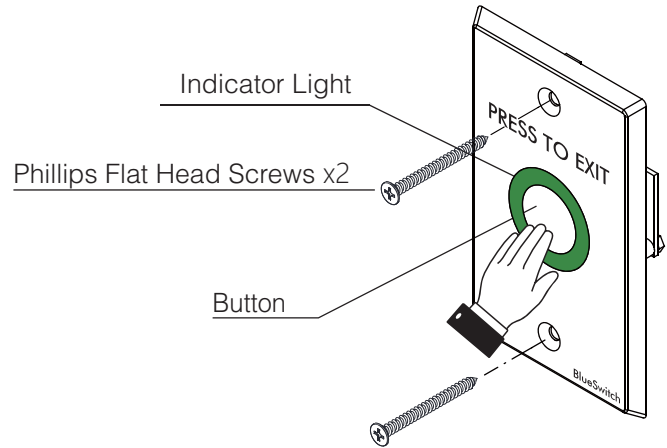

◆ Wiring Diagram

The BTS-500BT includes one pair of NO and NC output contacts, which can directly connect to a locking device or connect in parallel or series with access control systems.

* Reed Switch:

Door closed status: NO contact
Door open status: NC contact

Note:

1. Make sure that the power input and relay rating output (5A 250VAC/5A 30VDC) are correct.
2. Make sure that the "+" and "-" wires are connected correctly.
3. The door strike or relay must have a varistor or a diode across the door strike terminals to suppress the back EMF of the strike. Failure to do so will damage the relay contacts and electronic components, or even burn the controller.

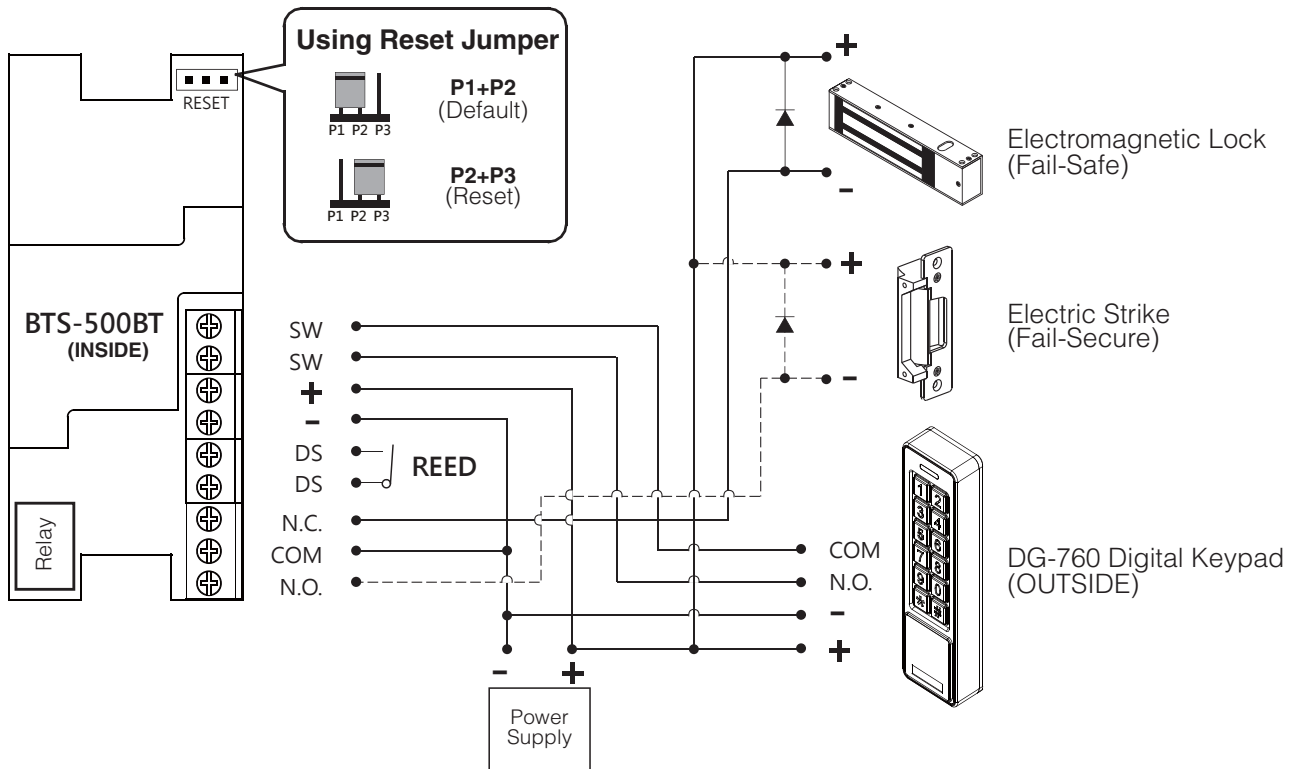

◆ Application

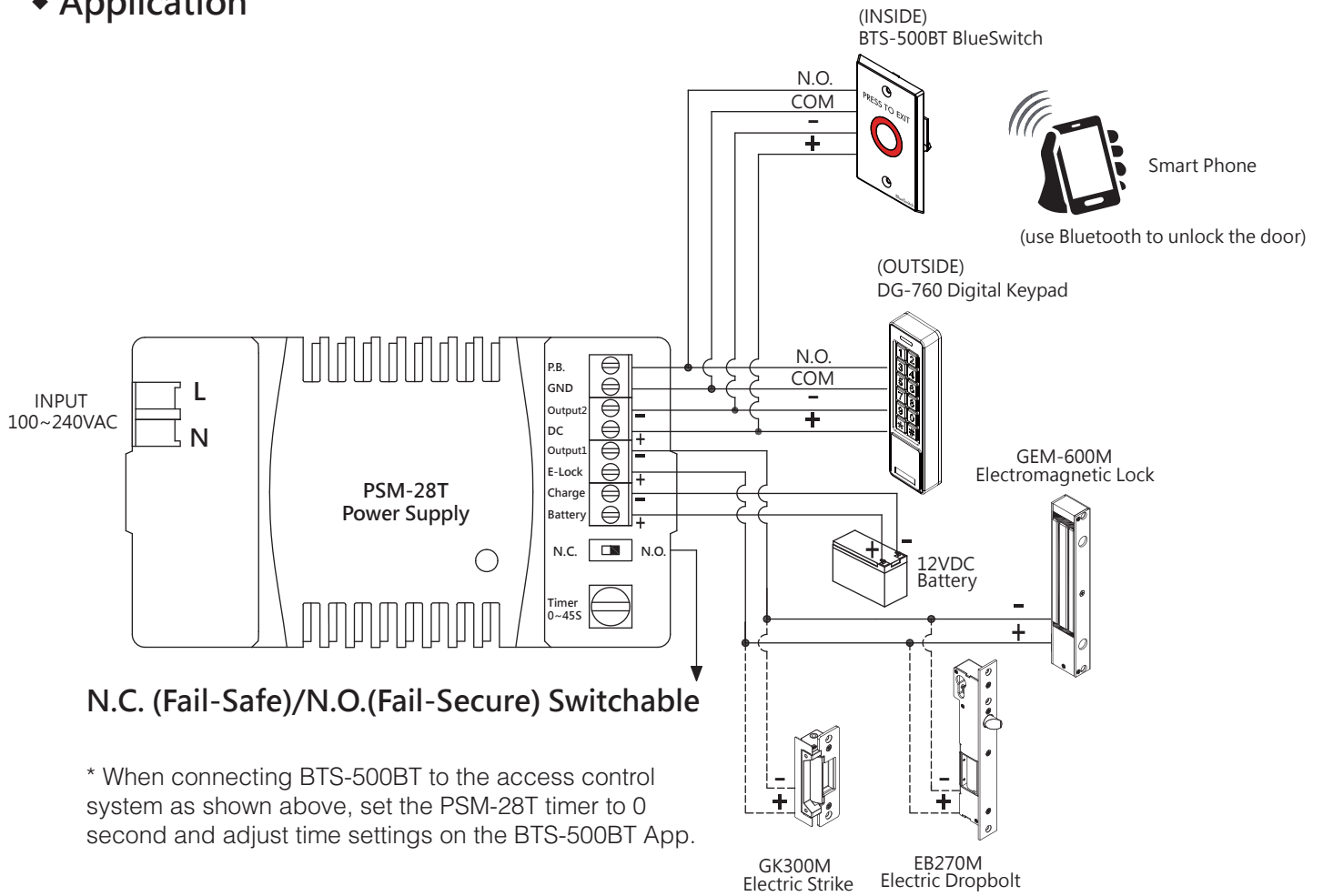

◆ Warranty

The product is warranted against defects in material and workmanship while used in normal service for a period of 1 year from the date of sale to the original customer. The policy is one of continual development and improvement; therefore reserves the right to change specifications without notice.

◆ App Guide

1. Download BlueSwitch App to Open Your Doors with Your Smartphone



Download BlueSwitch App from Google or Apple App Store depending on what kind of smartphone you use. Smartphone compatibility : Android 5.0 and up, iOS 9.0 and up.

2. App Main Page Introduction

① Login

Administrator : Enter Admin ID and Passcode to login.
Admin ID : ADMIN
Default Admin Passcode : 12345 (Passcode : 4~8 digits)

User : Enter User ID and User Passcode to login.
User ID and User Passcode are given by the Administrator.

[Note]

- 1.) Administrator ID "ADMIN" can not be changed. Please change Admin's default passcode "12345" right after you login as the Admin. Go to setting page, press Admin Passcode to Edit Admin Passcode.
- 2.) Login Success / Login Failure indications will be shown as following :
Login Success :
You Have Successfully Logged In. You May Now Unlock A Door.
Login Failure :
Login Failed. Please Verify Your Login Information Or Contact Your Administrator.

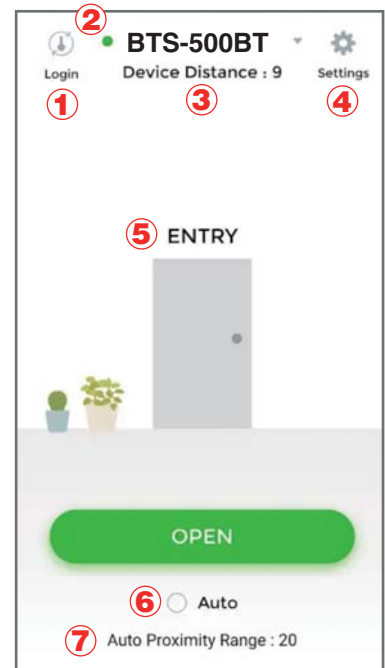

② Device name

Tap and Choose which device you want to unlock by pulling down the Device name listing.

③ Device distance

The distance between you and the Bluetooth BlueSwitch Push Button. The distance range is between 0 to 20 upon Bluetooth signal strength and different circumstances.

④ Settings

Tap "Settings" to view or change setting functions.

⑤ ENTRY

Press  button or the door icon  to unlock the door.

⑥ Auto

Tap "Auto" to enable Auto unlock function to access.
Make sure to disable "Auto" before pressing  if you want to enter Settings page.

Settings

⑦ Auto Proximity Range

Adjust Auto Proximity Range in Settings page. The range is between 0 to maximum 20 and it may have different results under different circumstances upon Bluetooth signal strength.

◆ App Guide

3. Administrator "Settings" Page Introduction

Tap "Settings" to view or change setting functions.

① **Users** : (See Figure 1 and 2 below)

- a. **Add / Delete / Edit** user information.
- b. **ID** (Up to 16 characters)
- c. **Passcode** (4~8 digits)

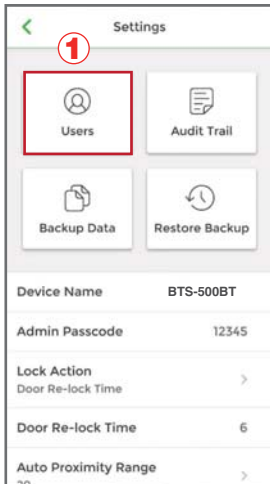

Figure 1

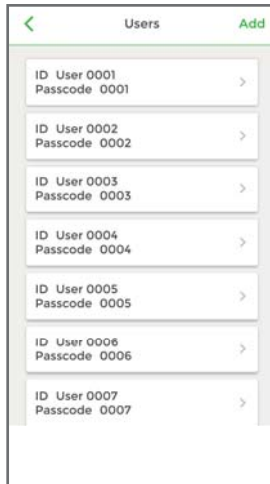

Figure 2

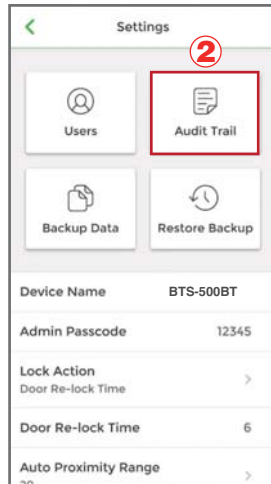

Figure 3

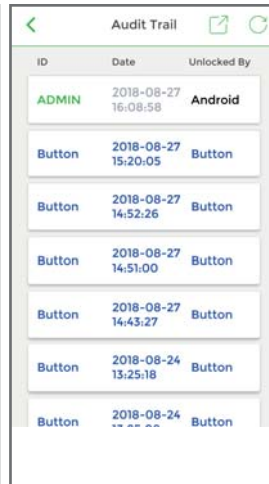

Figure 4

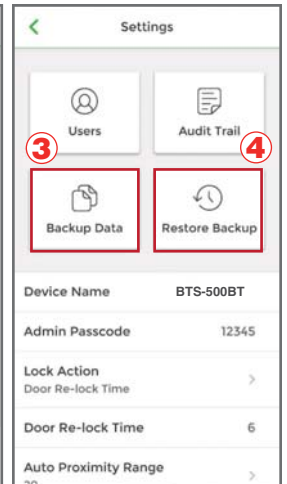



Figure 5

② **Audit Trail** : (See Figure 3 and 4)

- a. Audit Trail is tracking last 1000 event logs.
- b. Enter a user ID to search events for a user.
- c. Tap  to export all events to excel file.
- d. Tap .

② **Backup Data** : (See Figure 5)

Backup Data is to backup Users, Admin Passcode, Lock Action, and Door Re-lock Time to Administrator's phone and can be restored except Device Name, Auto Proximity Range, and Audit Trail logs.

Step 1 : Press "Backup Data", the App will show :

Step 2 : Press Confirm, the App will show :

③ **Restore Backup** : (See Figure 5)

Restore the last backup data by Admin's phone to another BlueSwitch Push Button.

Step 1 : Press "Restore Backup", the App will show :

Step 2 : Press Confirm, the App will show :

◆ App Guide

Administrator ” Settings” Page Introduction Continued : (See the Figure)

- Device Name : Edit Device Name (Up to 16 characters)
- Admin Passcode : Edit Admin Passcode (4~8 digits)
- Lock Action : (3 options)
Choose Door Re-lock Time, Door Always Unlocked, and Door Always Locked.
- Door Re-lock Time : 6 seconds by default. You can modify Door Re-lock Time from 1 to 1800 seconds.
- Auto Proximity Range : Adjust Auto Proximity Range here. The range is between 0 to maximum 20 and it may have different results under different circumstances.
- Device Time : Make sure the Device Time is precisely synced with your current time zone to have correct and precise access data and information.
- About us : View Device Model, App version, Website and E-Mail information.
- Firmware version : See Firmware version of your Bluetooth BlueSwitch Push Button.

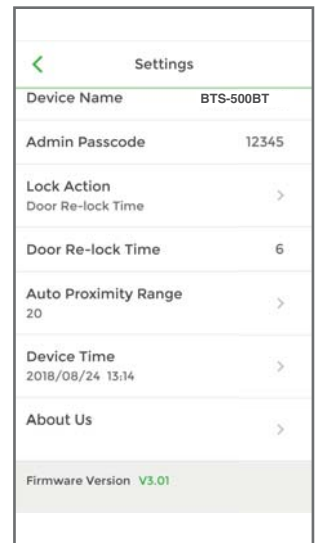

4. User's ” Settings” Page Introduction

Tap “Settings” to view or change setting functions. (See Figure 6 below)

- Device Name : User can only view the Device Name. (See Figure 7 below)
- Auto Proximity Range : User can adjust Auto proximity range between 0 to maximum 20 to access. May have different results under different circumstances. (See Figure 8 below)
- About Us : View Device Model, App version, Website and E-mail information. (See Figure 9 below)

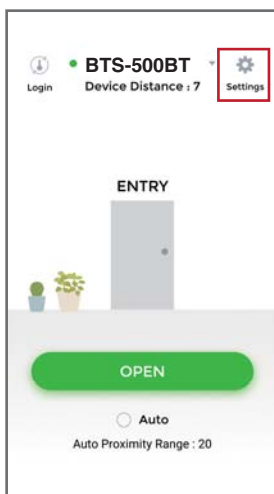

Figure 6

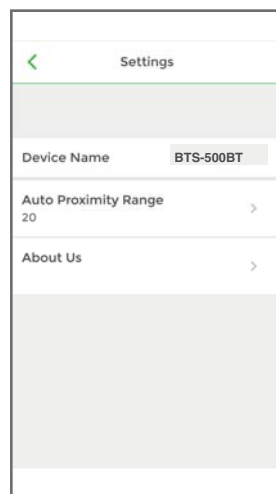

Figure 7

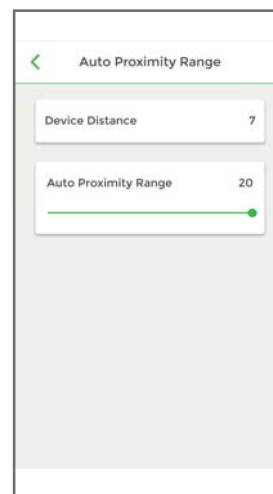

Figure 8



Figure 9